

KNIME Flow Control Guide

KNIME AG, Zurich, Switzerland
Version 5.4 (last updated on)



Table of Contents

Introduction.....	1
Flow variables.....	2
Creating flow variables.....	2
Using flow variables.....	7
Loops.....	11
Loop commands.....	14
Using flow variables in loops.....	15
Breakpoint node.....	16
IF and CASE Switches.....	18
IF Switch node.....	18
Defining the active port via a flow variable.....	19
CASE Switch Data (Start) node.....	22
Error handling.....	24

Introduction

Not all workflows have a static input and only one branch. Often, data are updated regularly, and some settings can be different from time to time. In other cases a workflow might have branches and a rule that determines which branch to follow.

In this guide, the tools available in KNIME Analytics Platform to control the flow in the needed direction are introduced.

In particular this guide explains how to:

- Parametrize settings using flow variables
- Repeat a part of the workflow for different inputs
- Define a rule to activate a branch
- Provide an error handling branch if node execution fails

The nodes that come in hand here are shipped automatically with the KNIME Analytics Platform and do not require the installation of any extension. You can find these nodes in the node repository under the *Workflow Control* category as shown in [Figure 1](#).

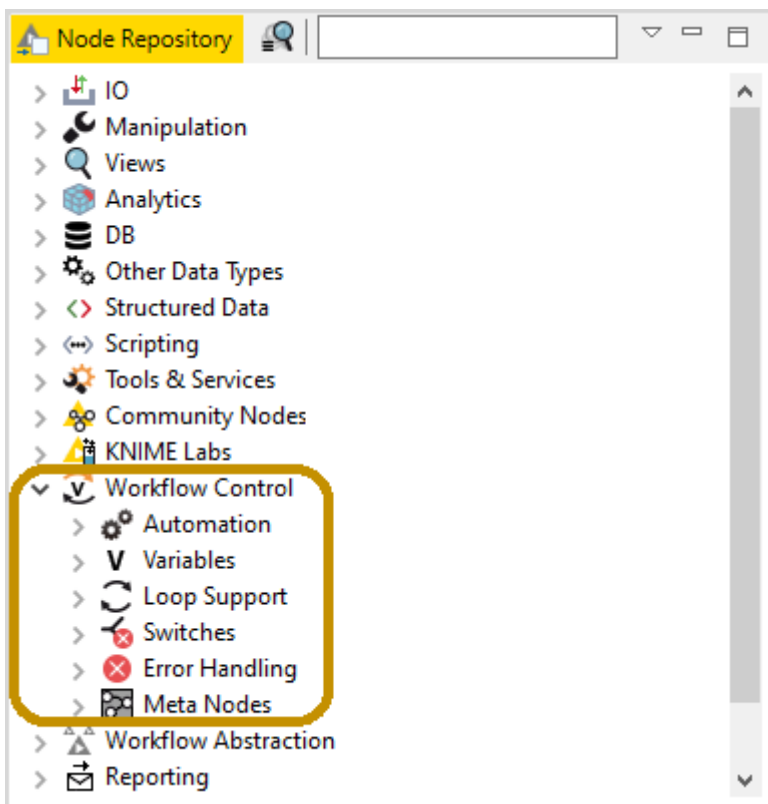

Figure 1. The Workflow Control nodes in the node repository

Flow variables

Flow variables are parameters with string, integer, double, arrays, or Path values. These parameters can be used to avoid manually changing settings within the nodes of a workflow when a new execution with different settings is required. Flow variables are available only for the downstream nodes in the workflow.

Creating flow variables

To create flow variables you have the following possibilities:

- Convert a table row into flow variables
- Export a node configuration as flow variable
- Use [Configuration](#) and [Widget nodes](#)
- Combine or modify existing flow variables

The first two options are introduced in this section. The Widgets and Configuration nodes are explained in more details in the [Components Guide](#). However, an example that makes use of this type of nodes in the context of creating a flow variable is available on [KNIME Hub](#). An example of the last option is the Rule Engine Variable node, which is introduced in the [IF and CASE Switches section](#).

Converting a table row into flow variables

The Table Row to Variable node, converts each column of the first row of a data table into a flow variable. In the example in [Figure 2](#), which is available on [KNIME Hub](#), the Table Row to Variable node is connected to Group By and Sorter node which respectively group the original data by country, counting how many times an entry in the data corresponds to a specific country and sorts the data accordingly, as shown in [Figure 3](#).

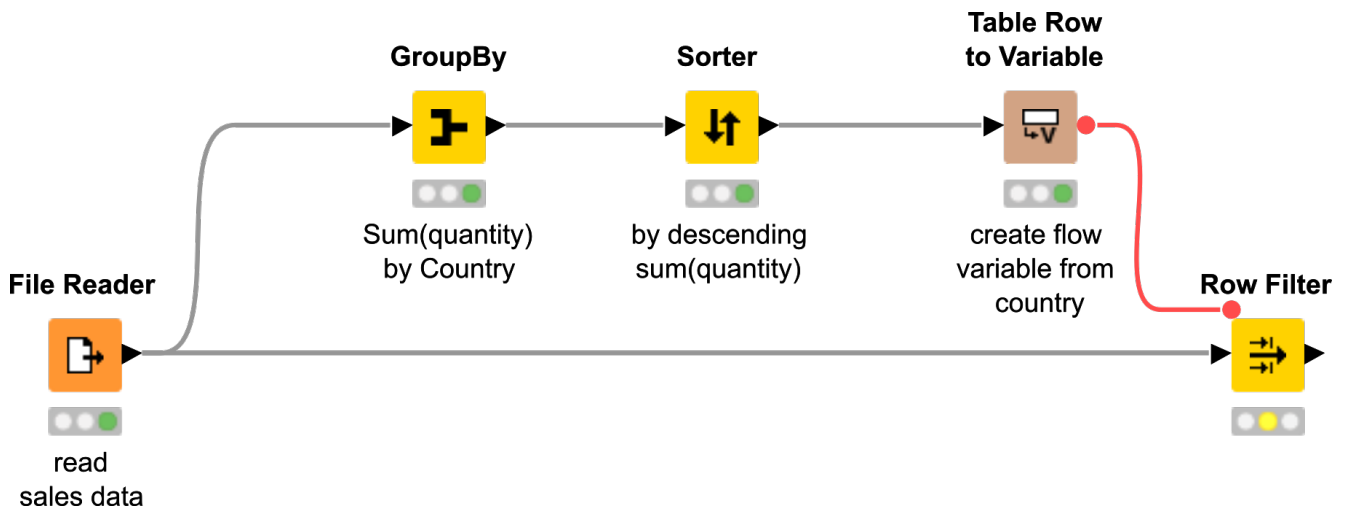

Figure 2. Converting first row of a data table to flow variables

Row ID	country	Sum(qu...)
Row3	USA	133
Row2	Germany	102
Row1	China	40
Row0	Brazil	35
Row4	unknown	1

Figure 3. Data grouped and sorted according to sales by country

The output of the Table Row to Variable node is shown in Figure 4. The column names in the data table are now the names of the flow variables, while the values of the first row are the corresponding values of the flow variables.

I...	Ow...	Name	Value
0	7:11	s country	USA
0	7:11	i Sum(quantity)	133
0	7:11	s RowID	Row3

Figure 4. First row converted to flow variables



In the video [From Data to Variables](#) this is explained in more detail.

Exporting a node configuration as flow variable

Another option to create a new flow variable is to export a node configuration. In this case

the flow variable acquires the same value used for the node configuration. The name for the flow variable is defined in the node configuration dialog.

Some configuration options have a flow variable icon next to them, for example the string pattern in the Row Filter node configuration dialog shown in [Figure 5](#).

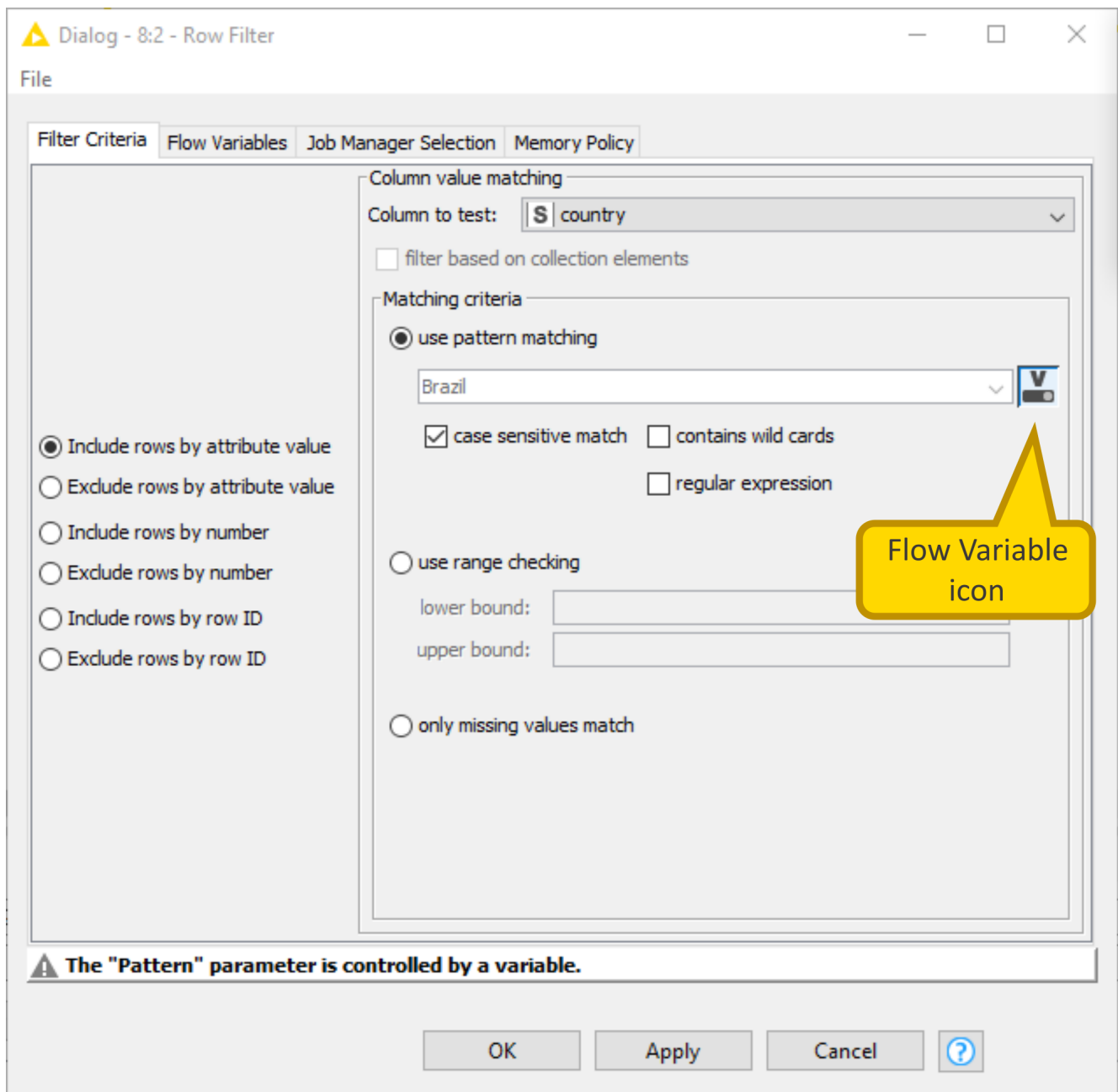

Figure 5. Flow variable button in a Row Filter node dialog

To export a node configuration that has a flow variable icon next to it, open the node configuration dialog and follow these steps:

1. Define the node configuration value in the corresponding field
2. Click the icon and select *Create Variable* in the dialog that opens, shown in [Figure 6](#)

3. Write the flow variable name in the field that activates.

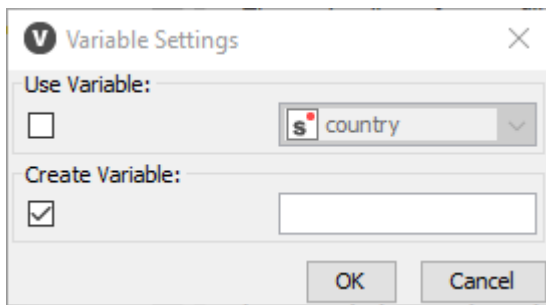

Figure 6. Variable Settings dialog

If there is no flow variable icon next to the setting to be exported, follow these steps:

1. Define the node configuration value in the corresponding field
2. Open the *Flow Variables* tab in the node configuration dialog
3. Write the flow variable name in the text field close to the drop-down menu in the row corresponding to the node configuration to export, as shown in [Figure 7](#).

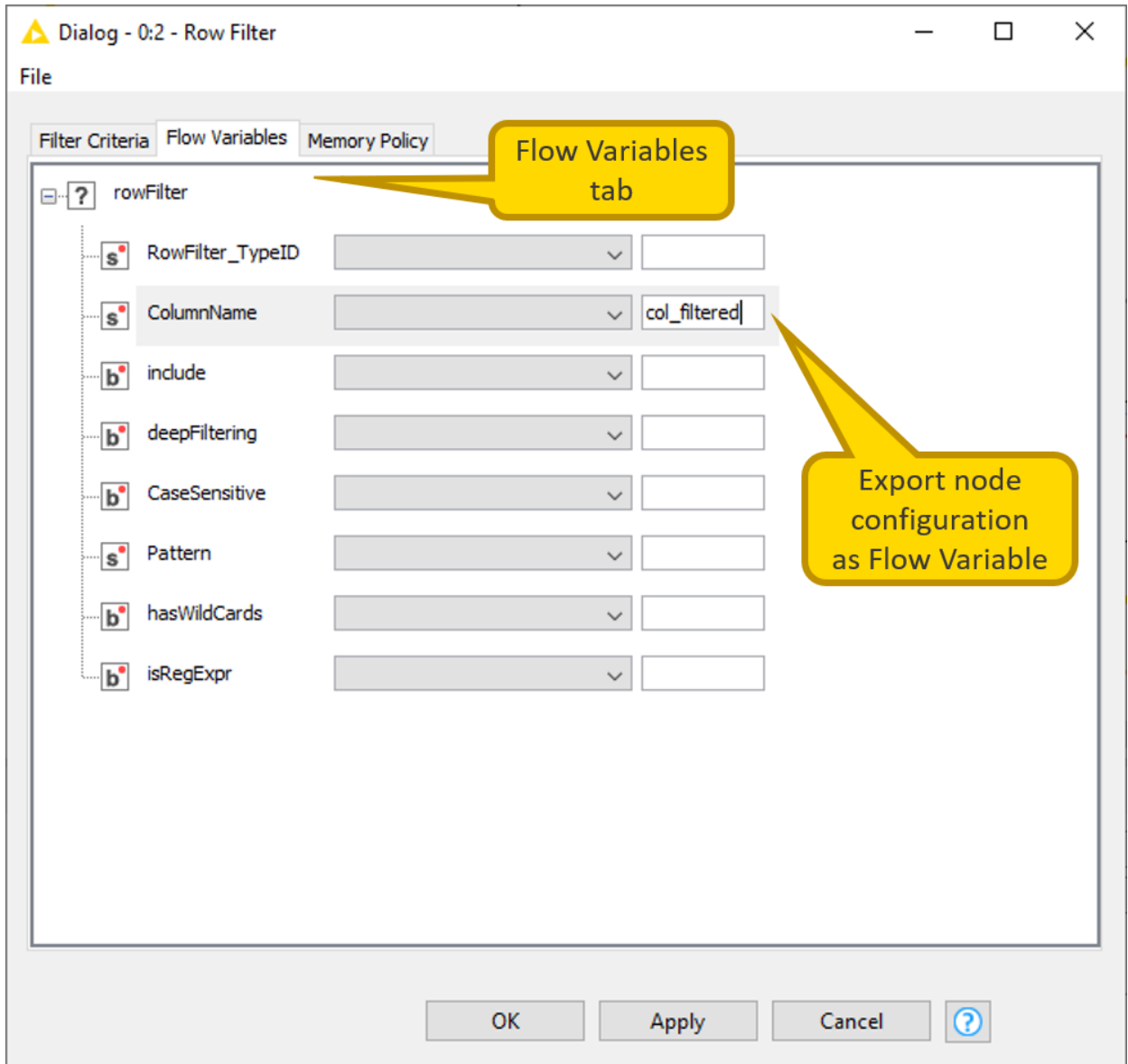

Figure 7. Flow Variables tab in a node configuration dialog

Now, the *Flow Variables* tab in the output table view of the node, shows the exported flow variable, as in [Figure 8](#).

The image shows a table view titled "Filtered - 8:2 - Row Filter" with tabs for "Table", "Spec", "Properties", and "Flow Variables". The "Flow Variables" tab is active, displaying a table of exported flow variables:

...	...	Name	Value
0 8:11	i	Sum(quantity)	133
0 8:11	s	RowID	Row3
0 8:11	s	country	USA
0 8:2	s	col_filtered	country

Figure 8. Flow Variables tab in a node output

Using flow variables

Flow variable ports

The flow variable ports are red circles above each node. Each node has flow variable ports, but for most nodes they are hidden by default. You can make them visible by right clicking a node and selecting *Show Flow Variable Ports* in the context menu as shown in [Figure 9](#).

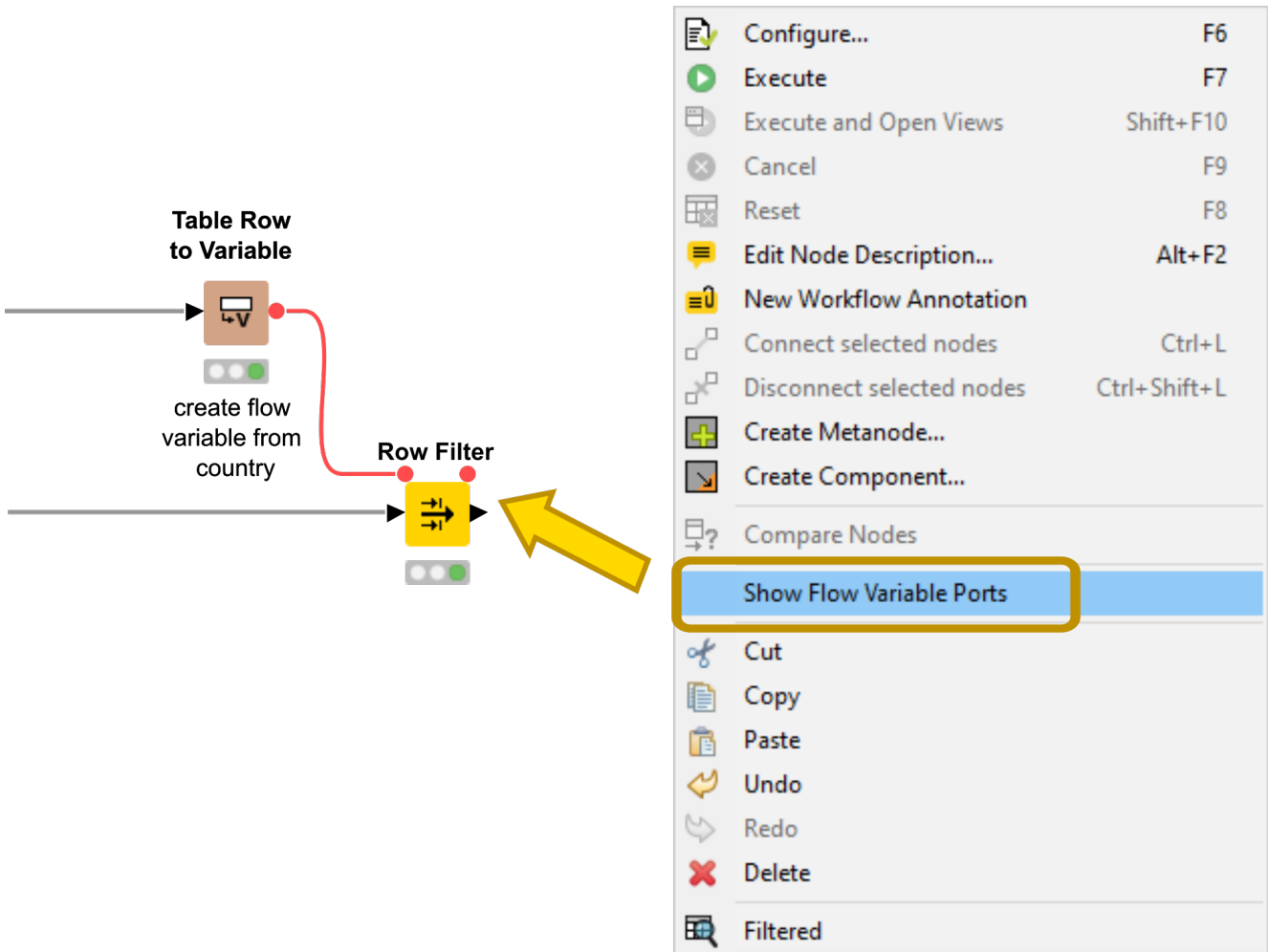

Figure 9. Showing flow variable ports

Overwriting node configurations with flow variables

In the previous section, we explained how to create flow variables. Here, we show how to use a previously created flow variable to configure a node.

In case you want to use a flow variable you need to first connect the node where the flow variable is created to the following one. If they are not connected already via any other port, use the **flow variable ports**. You need to create the connection only once, then the transferred flow variables are available for all subsequent nodes in the workflow.

To use a flow variable follow these steps:

1. Open the configuration dialog of the node whose setting you want to overwrite via the flow variable. The flow variable icon is not always present in the node configuration dialog, but you can find it next to node configurations that are often overwritten by flow variables.
 - a. If the chosen configuration setting has a flow variable icon next to it, click it and in the *Variable Settings* dialog that opens select *Use Variable*. Then select the flow variable from the drop-down menu, as shown in [Figure 10](#).

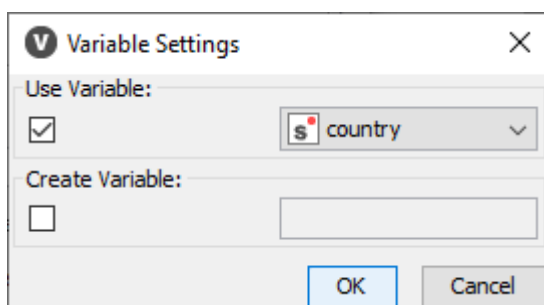

Figure 10. Define a specific node configuration by a flow variable

- b. If the flow variable icon is not present, go to the *Flow Variables* tab, navigate to the chosen node configuration and select the flow variable from the drop-down menu as shown in [Figure 11](#).

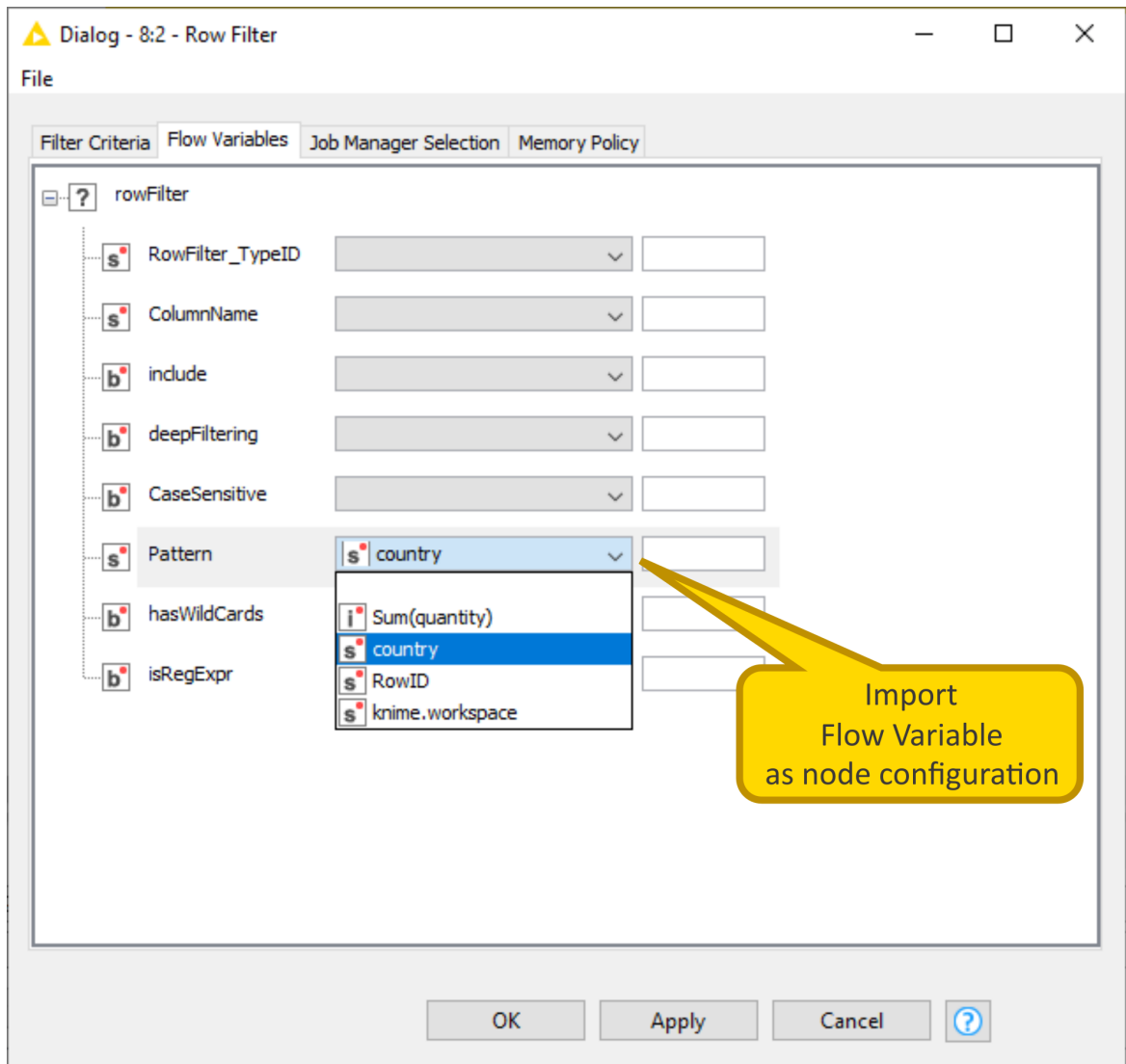

Figure 11. Overwriting node configurations in the flow variables tab

When you overwrite a node configuration with a flow variable, a warning message appears in the lower part of the node configuration dialog pointing out which node configuration is overwritten, as shown in [Figure 12](#).

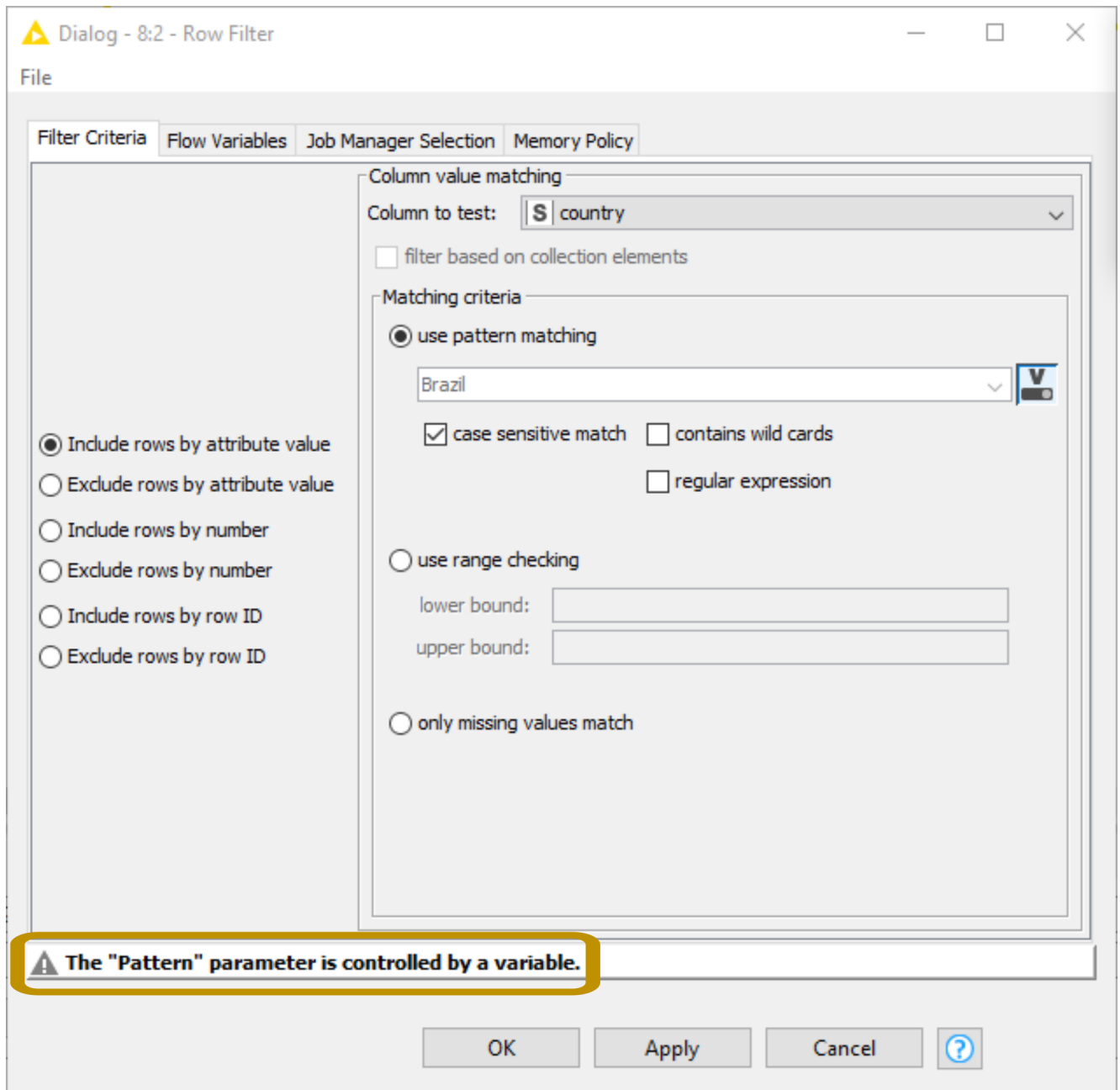

Figure 12. Warning message in lower part of configuration dialog

Loops

Loops iterate over a certain part of the workflow. Each iteration, a repeated procedure, has different input. What changes for each iteration can be a parameter value, dataset, subgroup of the same dataset, single column, or single row as flow variables.



In the videos [What is a Loop?](#) and [Counting Loop](#) we explain the loop concept and build a simple example loop.

A loop in KNIME begins with a Loop Start node and ends with a Loop End node. The operations that are performed for each iteration are executed in the loop body. Generally, the Loop Start node is responsible for increasing the iteration counter and for sending the data to the loop body, which is then responsible for executing sub-workflow steps. After those are performed the Loop End node checks if the end condition is fulfilled, and if this is not the case the Loop Start node increases the counter and performs the loop body operations again. When the end condition is fulfilled, the Loop End node collects the data from the different iterations and the next step in the workflow is performed.

The loop in [Figure 13](#), which is available on [KNIME Hub](#), is an example where the Chunk Loop Start node is used to iterate over a table, which contains ten rows filled with the letter A, created with the Table Creator node.

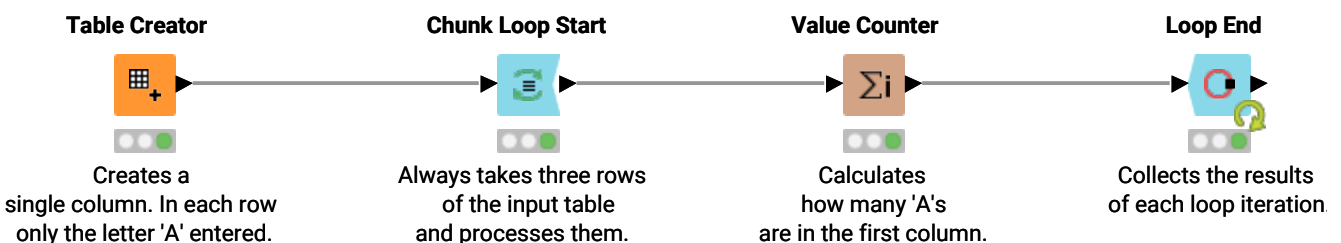







Figure 13. An example of loop with Chunk Loop Start node

The Chunk Loop Start node takes three rows of the input table and sends a chunk of the data to the loop body, which is made of a Value Counter node. Finally, a Loop End node collects the results of each loop iteration and ends the loop when the condition of reaching the last row of the input data is fulfilled.

KNIME Analytics Platform provides different loop start and loop end nodes for different types of loops. The loop start and loop end nodes are collected into [Table 1](#) and [Table 2](#). You will find these nodes in the node repository by navigating to *Workflow Control* → *Loop Support*.

Table 1. Loop start nodes

Node Icon	Loop Start Node	Explanation
	Counting Loop Start	Triggers loop for a predefined number of iterations
	Chunk Loop Start	Splits data into consecutive chunks for each iteration. Either the number of chunks or the number of rows per chunk is defined.
	Column List Loop Start	Iterates over a list of columns
	Generic Loop Start	Together with the Variable Condition Loop End node it iterates until a certain condition is met
	Table Row To Variable Loop Start	Converts every row in a table into row variables and iterates over them
	Group Loop Start	Iterates over groups of data that are defined based on a condition









Node Icon	Loop Start Node	Explanation
	Interval Loop Start	Increases a variable value for each iteration within a given interval
	Recursive Loop Start	Iterates over the output data table from the Recursive Loop End node
	Recursive Loop Start (2 Ports)	Iterates over the two output data tables from the Recursive Loop End (2 ports) node

Table 2. Loop end nodes

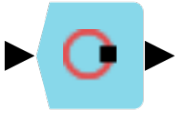
Node Icon	Loop End Node	Explanation
	Loop End	Concatenates the output tables from the different iterations
	Variable Condition Loop End	Together with the Generic Loop Start node it executes a loop until a certain condition is met

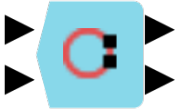
Node Icon	Loop End Node	Explanation
	Loop End (2 ports)	Concatenates the output tables from each iteration into two separate tables when each iteration produces two output tables
	Loop End (Column Append)	After each iteration the output table is joined with the output table from previous iteration
	Recursive Loop End	Passes the output table from an iteration to a Recursive Loop Start node until either the maximum number of iterations, minimum number of rows, or a certain condition is met
	Recursive Loop End (2 ports)	Passes the output table from an iteration to a Recursive Loop Start (2 ports) node until the maximum number of iterations, minimum number of rows, or a certain condition is met
	Variable Loop End	Collects flow variables from each iteration. Can be used when the calculations are finished inside the loop and the output is not needed.

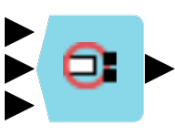
Loop commands

While executing a loop, you can follow the execution monitoring a selected node output using the [node monitor](#).

You have two ways of executing a loop.

- **Complete execution:** Right click the Loop End node and choose *Execute* from the context menu. Now a yellow loop sign is shown at the Loop End node while the loop steps are executed. As soon as it turns to green the loop is completely and successfully executed. To reset the loop you can reset any of the nodes that belong to the loop sub-workflow, by right clicking a node and choosing *Reset* from the context menu.
- **Step-wise execution:** Right click the Loop End node and choose *Step Loop Execution* from the context menu, to execute one iteration of the loop. At any time you can execute the remaining steps by choosing *Resume Loop Execution* from the context menu of the Loop End node. You can also pause the step-wise execution or cancel it, choosing *Pause Execution* or *Cancel* from the context menu of the Loop End node. In both cases this affects only the Loop End node, while the antecedent nodes will still be in the executed state.



The videos [Loop End Nodes](#) and [Loop Commands](#) explain loop end nodes in more detail and show guided loop execution options.

Using flow variables in loops

In the [Flow variables section](#) we introduced flow variables and their function. They are often used in loops and Table Row to Variable Loop Start and Variable Loop End nodes are two specific loop nodes with input and output flow variable type ports.

An example for Table Row to Variable Loop Start is shown in [Figure 14](#), and is also available on [KNIME Hub](#).

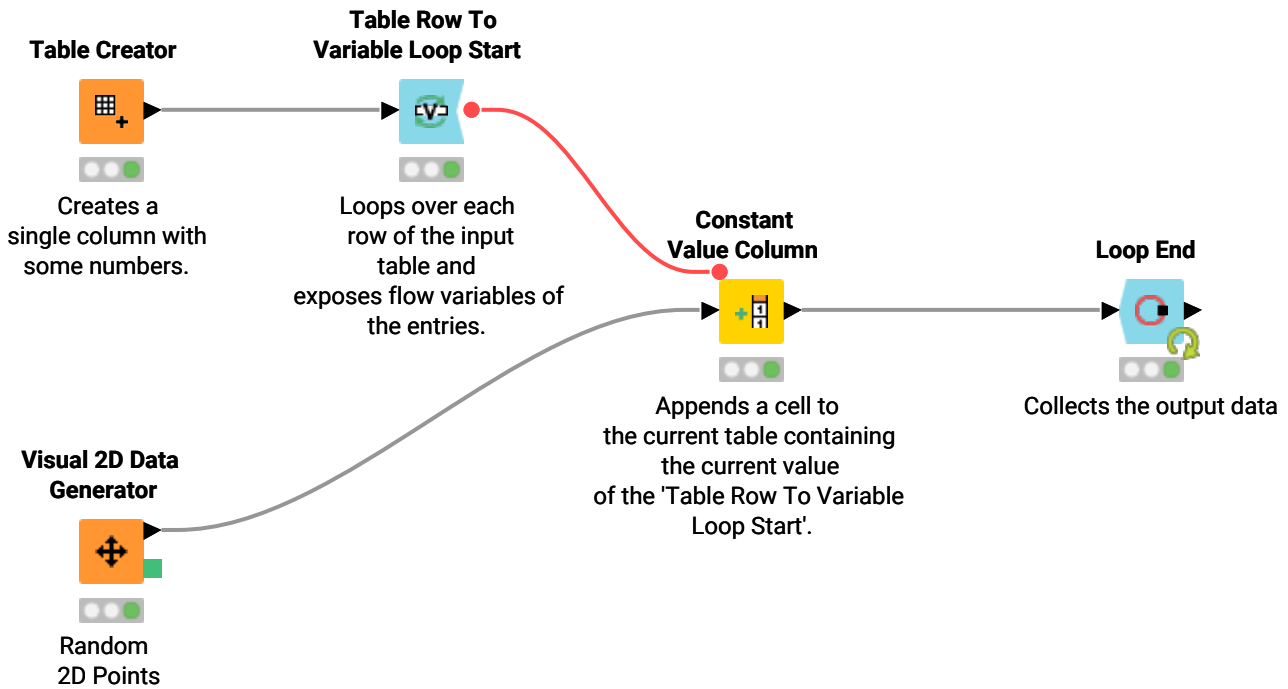

Figure 14. An example of loop with Table Row to Variable Loop Start node

Similarly to the [Table Row to Variable node](#), the Table Row to Variable Loop Start node transforms the row of a table to a set of variables that have as name the column name and as value the corresponding value in the current row. It loops over each row of the input table and exposes the flow variables obtained to the loop body. In the example in [Figure 14](#), one of the flow variables obtained is used to overwrite the column value parameter setting of the Constant Value Column node, which appends a cell containing the current value to the current table.

Breakpoint node

In the node repository, under *Workflow Control* → *Loop Support*, Breakpoint node is also available. You can use it to halt execution when certain conditions are met. [Figure 15](#) and [Figure 16](#) show the use of this node to impair the execution of the loop when the input flow variable corresponding to the value of the customer segment is equal to three. You can also configure the Breakpoint node to halt execution when it receives as input an empty table, and active or inactive branch. You can also set a *Custom message* to be shown if the Breakpoint node condition is met. This workflow is also available on [KNIME Hub](#).

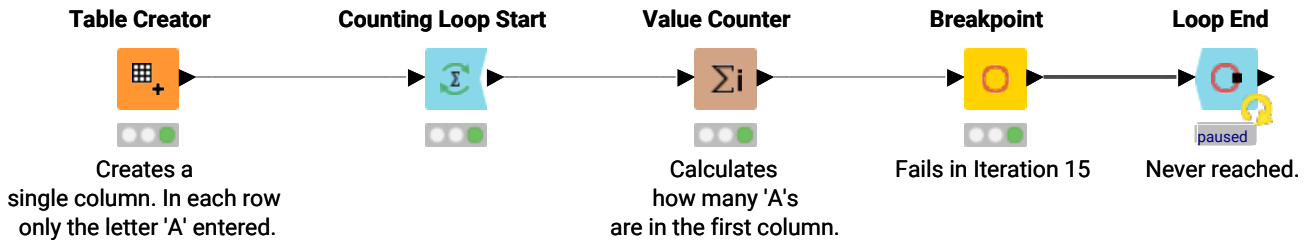

Figure 15. A workflow with a Breakpoint node

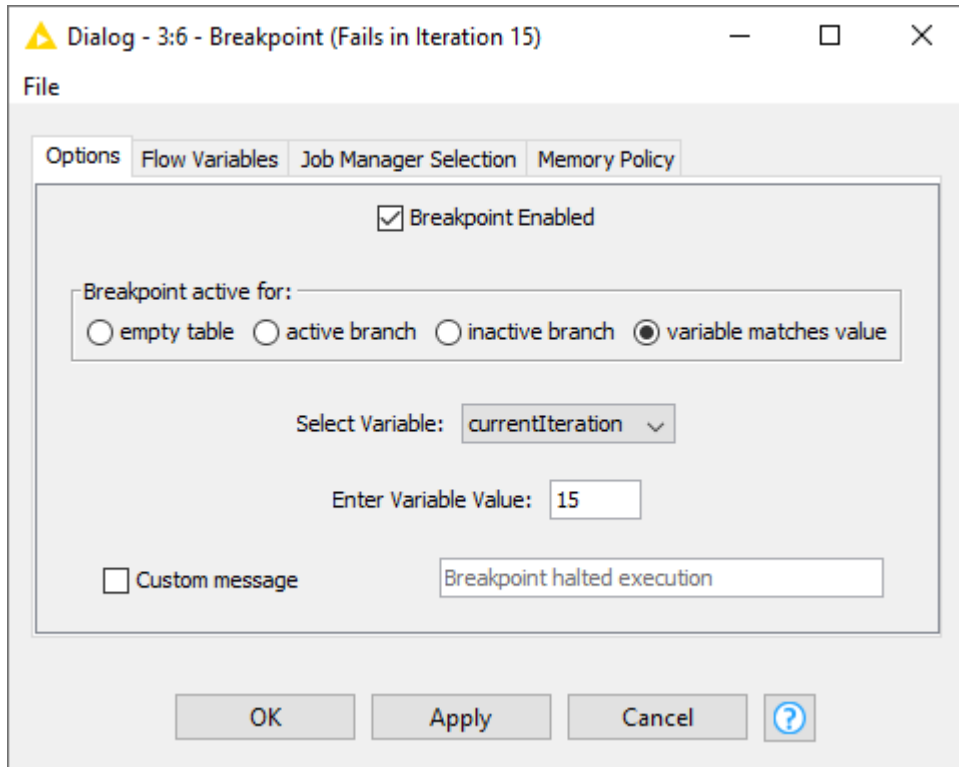

Figure 16. The Breakpoint node configuration dialog

IF and CASE Switches

In case you need to perform different operations on different groups of the data, you can use a logic which is able to split the workflow into branches. The IF and CASE nodes available in KNIME Analytics Platform have this function. The nodes for IF and CASE switches are located in the node repository under *Workflow Control* → *Switches*.

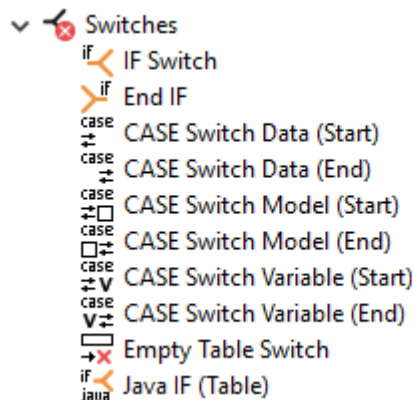

Figure 17. Switch type nodes

IF Switch node

The IF Switch node creates two branches in the workflow which can be alternatively activated or deactivated. This means, the nodes in the active branch or branches are executed and the nodes in the inactive one are not. In the node configuration dialog you can define the active branch either manually, or it can be dynamically controlled by a condition, through a flow variable.

The example workflow in [Figure 18](#), also available on [KNIME Hub](#), loops over an IF Switch to read in data row by row, to categorize the customers based on their call activity. When the loop is finished, the rows are concatenated back into the same table.

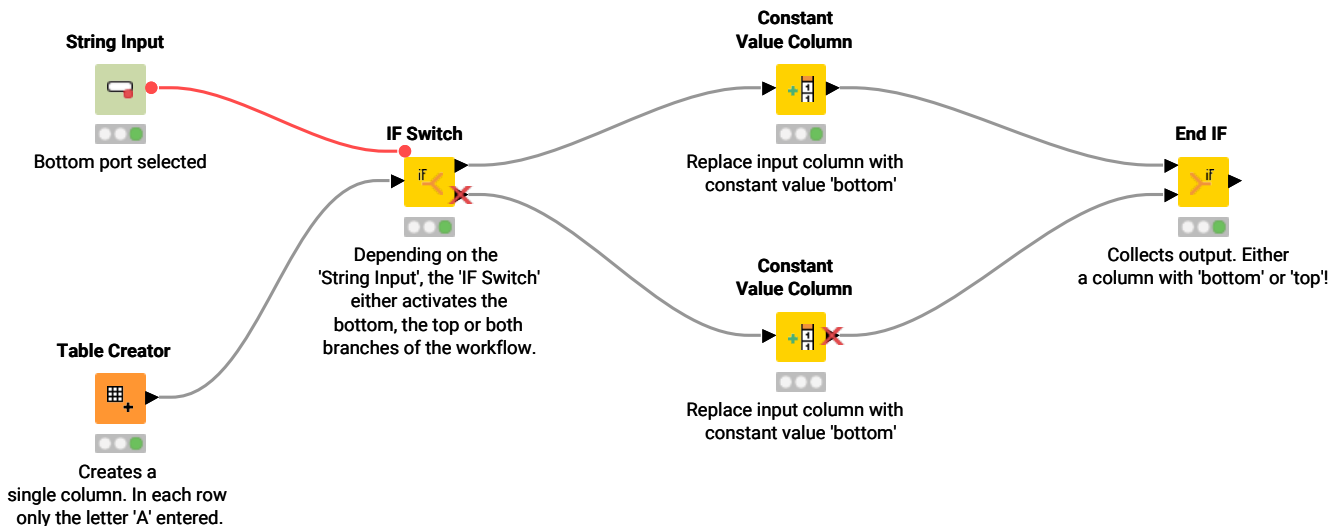

Figure 18. An example using an IF Switch node

In the workflow in [Figure 18](#), the IF Switch node has both data and flow variable input. The flow variable, created with the String Input node, defines the active branch. The data are then handled in the active branch.

Defining the active port via a flow variable

As shown in [Figure 19](#), the *Select active port* option is located in the *Options* tab of the IF Switch node configuration dialog. Here, you can manually select either both, bottom or top, to define the active branch. However, in the same way as in the [Overwriting settings with flow variables section](#), you can also use a flow variable to overwrite the active port option.

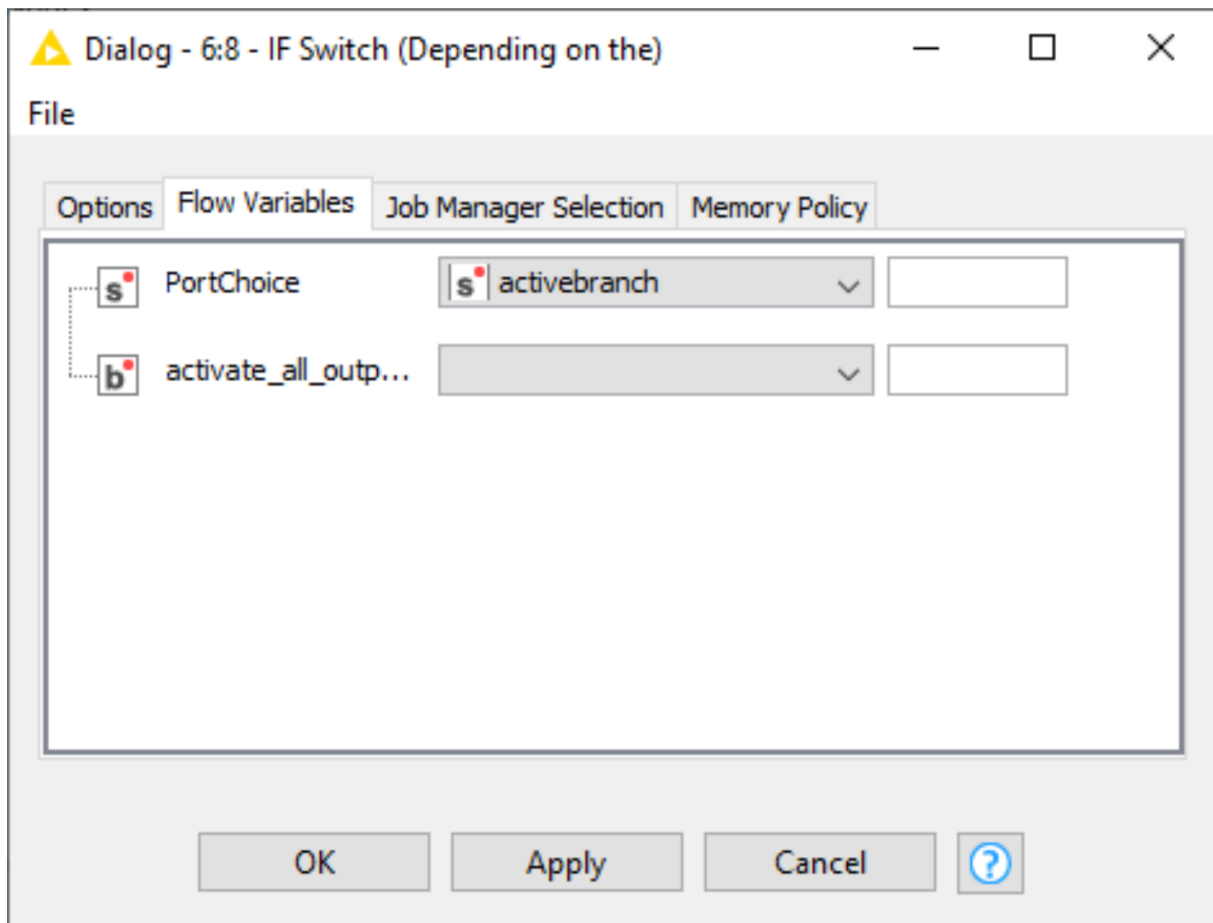
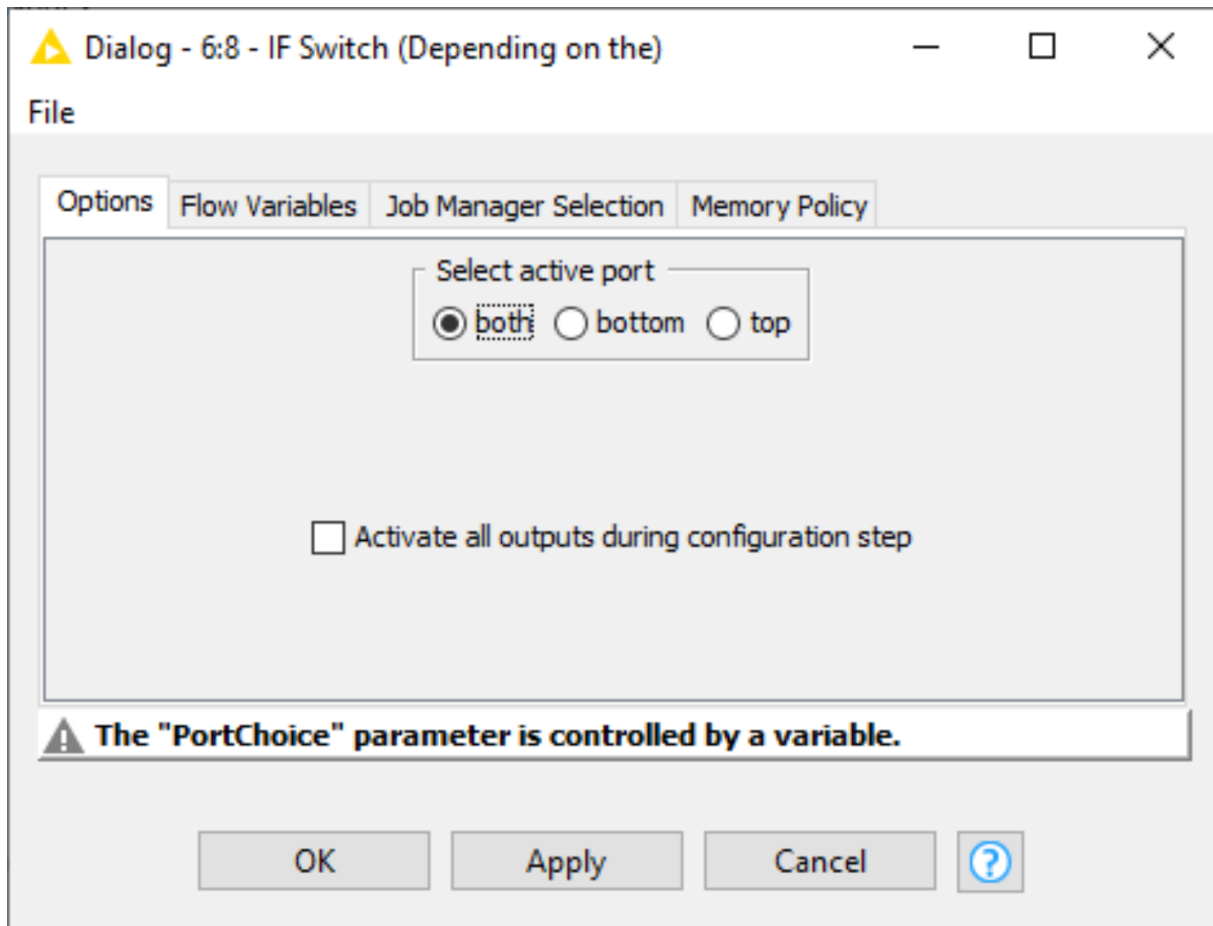

Figure 19. Defining active branch by a flow variable

First, you need to create a suitable flow variable. Since you need to use it to overwrite the *Select active port* option of the IF Switch node, you have to assign to it a string value equal to either both, bottom or top.

In the example shown in [Figure 18](#) this flow variable is created using a String Input node which allows to manually set the output flow variable to one of the suitable string values.

Another possibility is to automatically activate a branch according to some set condition, within a loop. In the example shown in [Figure 20](#) and available on [KNIME Hub](#), a loop is performed row by row over some data. Each row is then transformed in flow variables and, depending on the value of a specific column the IF Switch ports are activated.

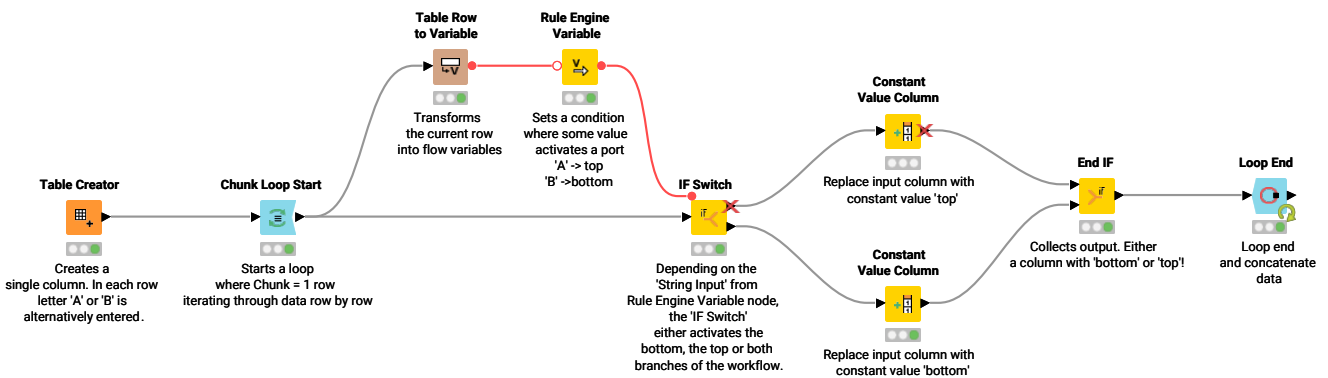

Figure 20. IF Switch combined with loop

The Rule Engine Variable node configuration dialog is shown in [Figure 21](#). Here the antecedents are defined using the flow variables and functions available while the consequent of a true condition is assigned with the => sign. The default outcome, i.e. the value assigned to all cases for which none of the rules is true, is defined using the syntax `TRUE => "default outcome"`.

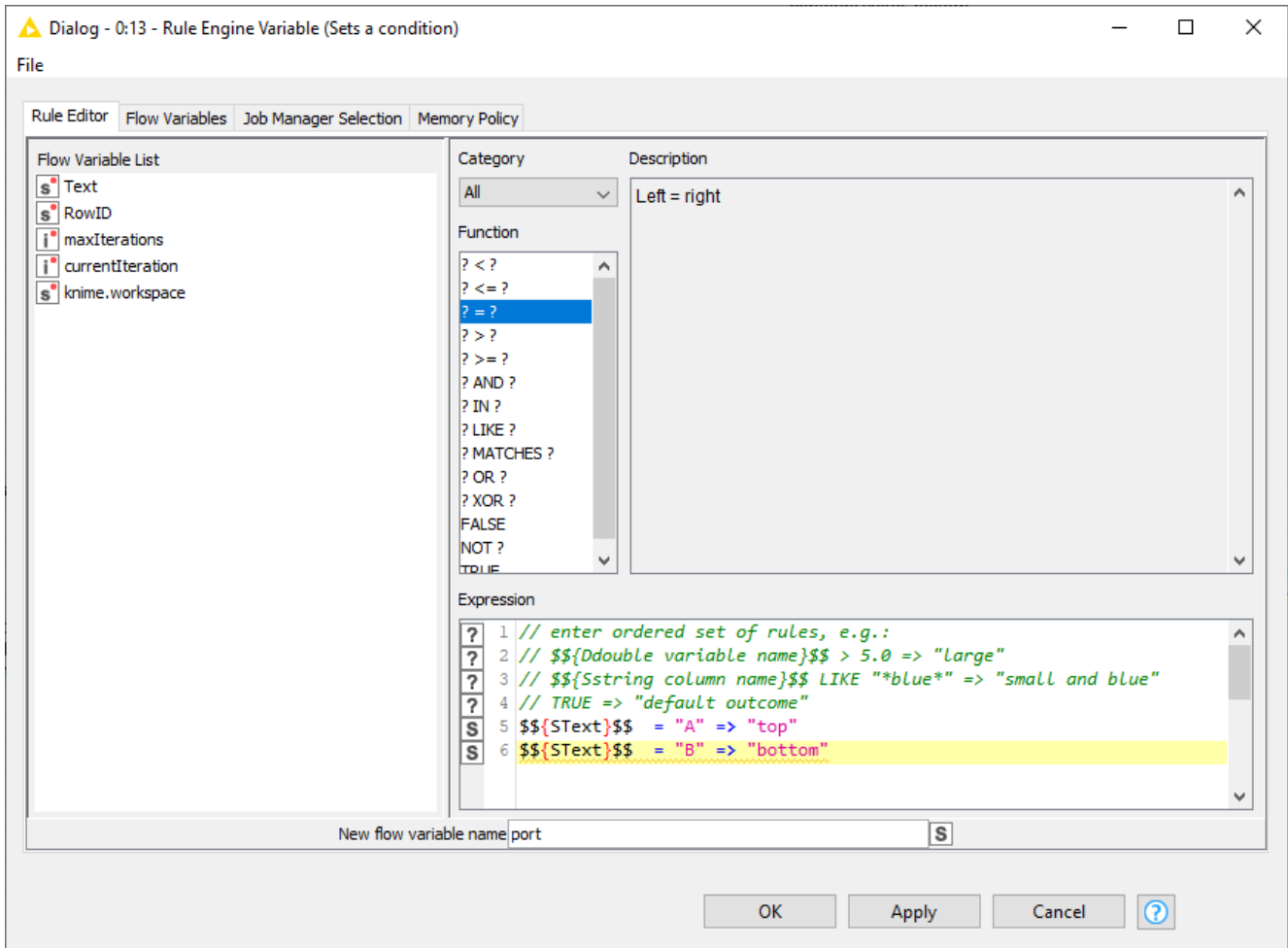

Figure 21. Defining flow variable values by condition

CASE Switch Data (Start) node

With the CASE Switch Data (Start) node you can activate one of three branches in a workflow. Similar to the IF Switch node, this can be either done manually or by using a condition.

Once the execution has finished, the tables resulting from the branches can be concatenated by using an End IF node or CASE Switch Data (End) node.

An example, similar to the one of IF Switch Data node, is shown in [Figure 22](#) and available on [KNIME Hub](#).

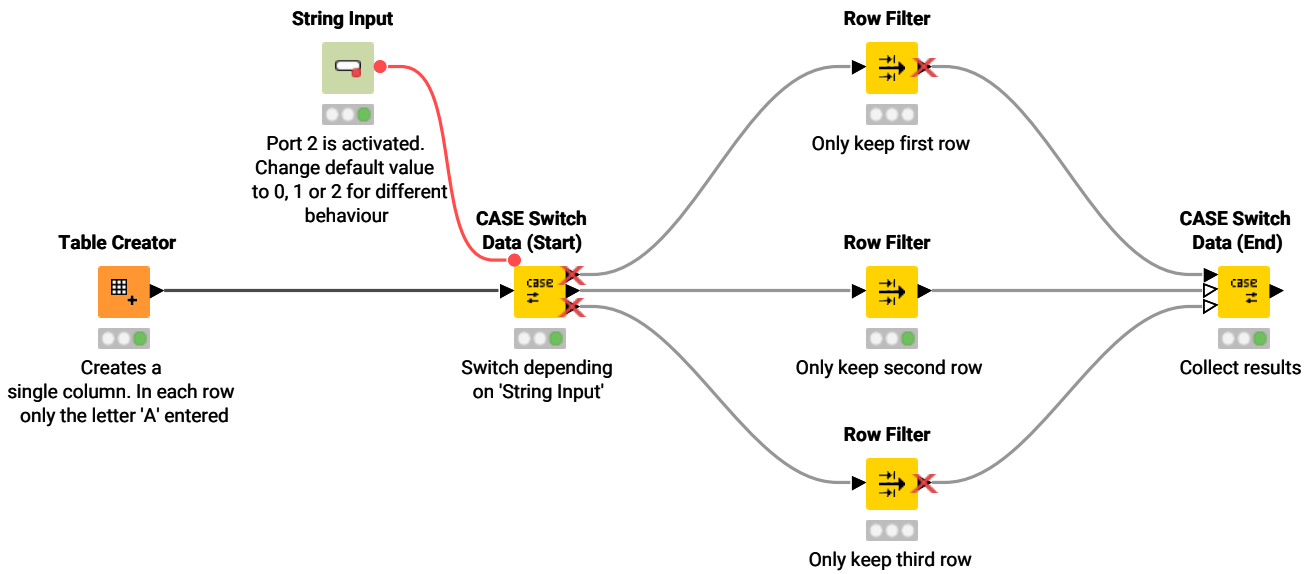

Figure 22. An example using a Case Switch node



Note that when using the CASE Switch, the possible values for the active output port are 0 for the top, 1 for the middle, and 2 for the bottom output port. That said, the functionality is similar, but the flow variable values are different.

Error handling

Different type of errors, such as a failing connection to a remote service, the invocation of a not accessible database, and so on, can occur when executing a workflow. To handle them you can use the Try-Catch enclosures. The Try part executes some node(s). If the execution fails, the Catch branch with error handling is activated. Otherwise the Default branch is executed. At the end of the Try-Catch enclosure, the results from either the successful or failed execution are collected. An example of a Try-Catch enclosure is shown in [Figure 23](#), which is available on [KNIME Hub](#).

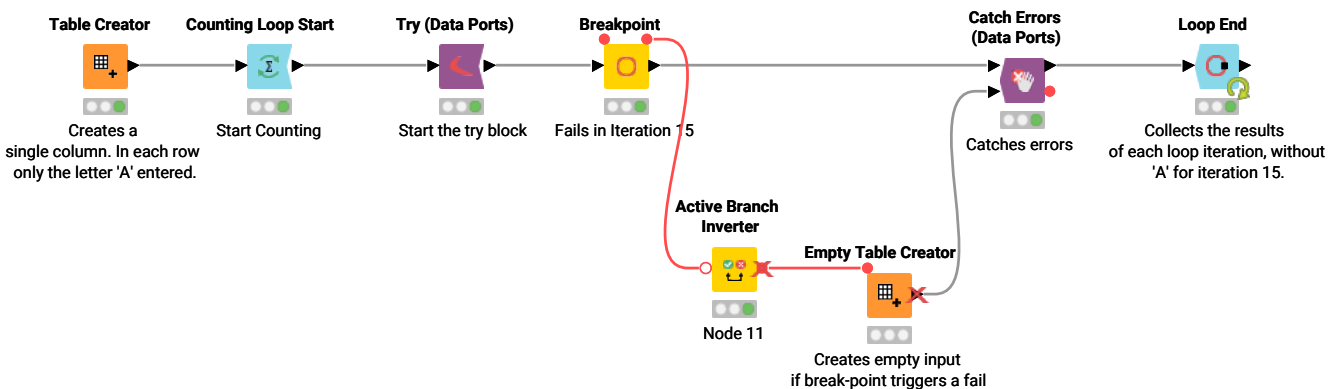

Figure 23. Error handling with a Try-Catch enclosure

In the workflow in [Figure 23](#), the Try (Data Ports) node begins the enclosure, followed by the Breakpoint node. The Breakpoint node is set to fail at the fifteenth iteration. Here, if execution of the Try part fails the Catch branch is executed.

The Active Branch Inverter node begins the Catch branch for error handling. This node makes an inactive branch active and active branch inactive:

- It activates a branch in the event that execution fails
- It deactivates a branch if execution is successful

The Catch Errors (Data Ports) node closes the Try-Catch enclosure:

- If execution is successful, the output of the node is the output from the Default branch. Therefore, the Default branch must be connected to the top input port of the Catch Errors (Data Ports) node.
- If execution fails, the output of the enclosure comes from the Catch branch, which must be connected to the bottom input port of the Catch Errors (Data Ports) node. The reasons for the failure are then reported in the flow variable output of the Catch Errors (Data Ports) node.

Besides data tables, the Try part can also be started with a flow variable, using the Try (Variable Ports) node instead.

One of the following four alternatives is available to end the Try-Catch loop:

- Catch Errors (Data Ports) shown in [Figure 23](#)
- Catch Errors (Var Ports) if the outputs of the Catch and Default branches are flow variables
- Catch Errors (Generic Ports) for models
- Catch Errors (DB Ports) for database queries.

You will find the nodes for a Try-Catch enclosure in the node repository by navigating to *Workflow Control* → *Error Handling*.

KNIME AG
Talacker 50
8001 Zurich, Switzerland
www.knime.com
info@knime.com